

ASSEMBLY INSTRUCTIONS

4 ROW AP BLEACHER × 21ft.

bleacherguys.com

Best Seats in the House.
W.H. Reynolds (Cambridge) Ltd.

REQUIRED ITEMS:

- (5) HDG 4 Row Bleacher Frames per
- (5) 2" × 6" × 58" Recycled Plastic Skid Sleepers
- (3) HDG Cross Brace Sets @62 7/8" (center bolts attached)
- (3) Double 2" × 10" × 21'0" Mill Finished Foot Planks
- (4) 2" × 10" × 21' 0" Anodized Seat Planks
- (1) Riser 2" × 10" × 21'0" Mill Finished Riser Board (underneath last row)
- (2) Riser 1" × 6" × 21'0" Mill Finished (under row #2 and #3)

ASSEMBLY TOOLS:

- 1/2" and 9/16" wrenches
- Tape measure
- Straight edge

HARDWARE:

- (10) 3/8" × 1-1/2" Hex Head Gr. #5 Bolts, Nuts and L/W (to fasten (3) cross brace to the HDG frame assembly)
- (120) Bolt Clip Sets (Aluminum Bolt Clip, HDG Carriage Bolt, HDG Nut) (to fasten (4) seat boards, (3) double footboards to frame assembly and (3) riser boards to frame assembly)

INSTRUCTIONS: Setting the Frames

- The (5) bleacher frames when spaced properly will have an overall measurement of 20'.
- Bolt the cross braces to Col #3 using the 3/8" × 1 1/2" Hex Head Bolt/Nut/Lock washers.
- The holes for these cross braces are under the foot board elevation (one set is doubled).
- These holes are 12 1/2" on center

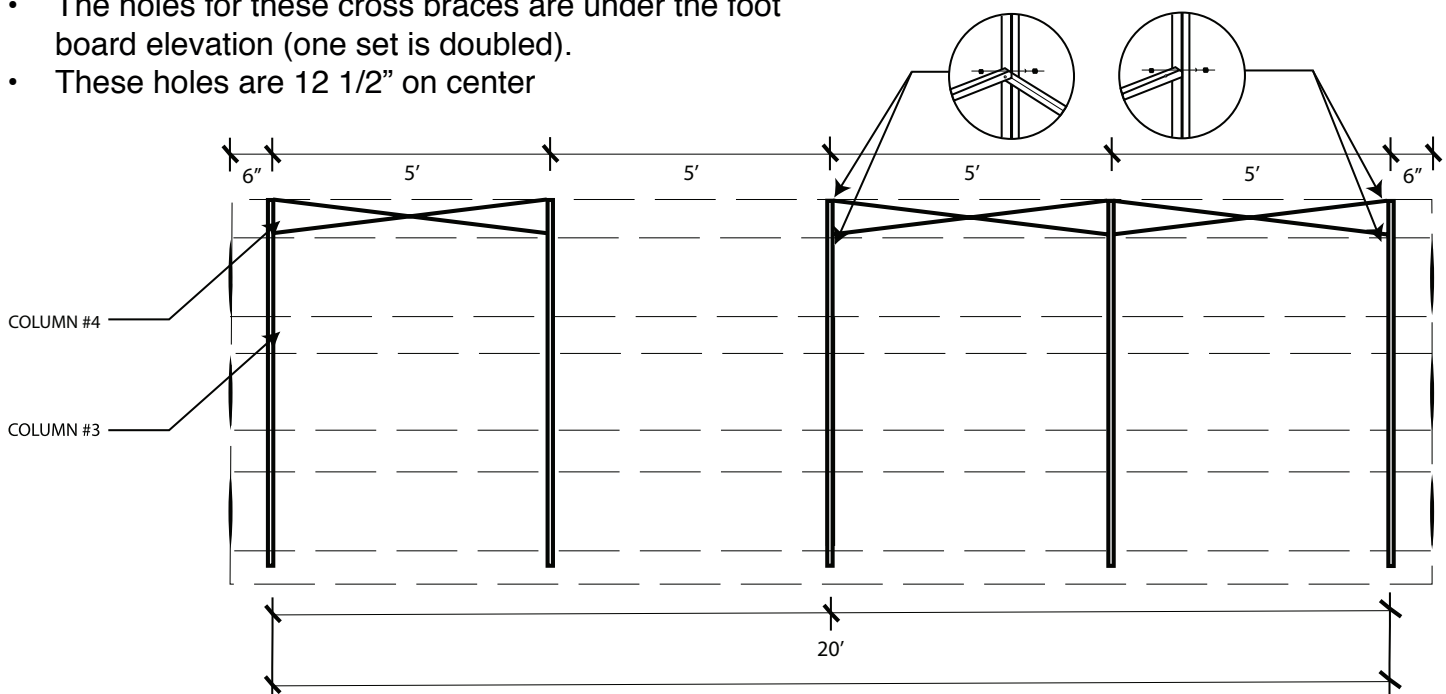

please note that the inside bay does not require cross braces

#1

#2

INSTRUCTIONS: Installing Aluminum

OPTION:

- The Anodized 2" x 10" seat boards may have been "End Capped" in factory and installed for you.
- The Mill Finished 2" x 10" foot boards and rear riser board may have been "End Capped" in factory and installed for you.
- The Mill Finished 1" x 6" row #2 and #3 riser boards may have been "End Capped" in factory and installed for you.

The order to install Aluminum is below:

You should use a 7 ft. straight edge to make sure the ends of all planks are aligned and the overhang should be equal.

1. Measure corner to ensure frames are square and perpendicular
 2. Install Row #4 seat board. This plank acts as a "straight edge" it aligns the (5) frames and spaces properly
 3. Install Row #2 footboard
 4. Install Row #1 seat board
 5. Install Row #2 seat board and Row #3 footboard
 6. Install Row #3 seat board and Row #4 footboard
- (1) Mill Finished Riser Board to be installed under row #4.
 - (2) Normal 1" x 6" Riser Board to be installed under row #2 and #3 using the bolt clip assemblies (same as seats and footboards).
- Tighten the nuts to the carriage bolts with adequate torque. The bolt clip will start to deflect slightly (bend) when tightened properly.
 - Please ensure to check hardware regularly to ensure nuts have not come loose

Please refer to drawings attached for reference

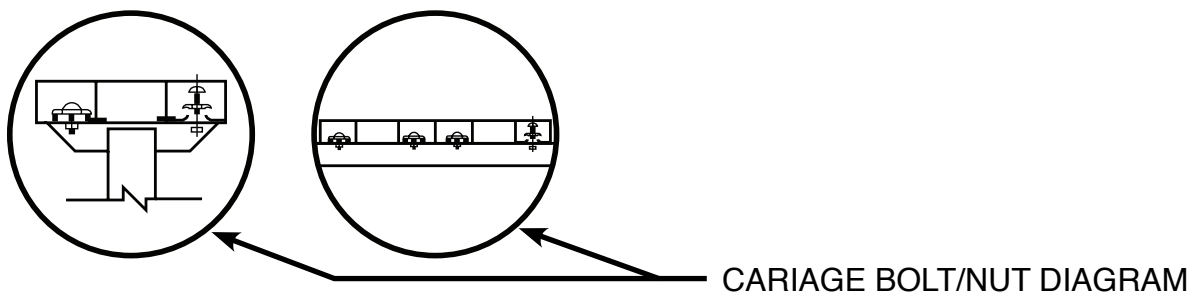

CONTACT

PHONE (TOLL FREE): 1-888-653-9721

P.O. BOX: 32144 CAMBRIDGE, ON

FAX: (519)-621-2386

ADDRESS: 58 COWANSVIEW RD. N3H 5M2

EMAIL: INFO@BLEACHERGUYS.COM

Any questions or concerns please contact using the information above

#3

#4

#5